

TREX SELECT T-RAIL® HORIZONTAL RAILING

Installation Instructions



NOTES:

- » TREX SELECT T-RAIL RAILINGS ARE DESIGNED TO BE INSTALLED OVER THE DECKING FRAME OR ON INSIDE OF RIM JOIST. NOTCHING OF PRESSURE-TREATED POSTS OR POSTS INSTALLED ON OUTSIDE OF RIM JOIST IS NOT ALLOWED.
- » All Select T-Rail Railing lengths are manufactured at CLEAR SPAN dimensions (spanning between space of posts): 72" for 6' and 96" for 8' clear span. Note that railings are designed to be slightly longer than required to allow for very slight play in post placement - trimming may be required. IT IS VERY IMPORTANT TO MEASURE FIRST.
- » IF INSTALLING RAILING OVER 6', THE TREX T-RAIL ALUMINUM RAIL STIFFENER MUST BE USED TO MEET CODE REQUIREMENTS.

Care and Cleaning

Maintaining the appearance of your Trex Select T-Rail railing is important. Occasional washing is recommended. Over time your railing may show signs of weathering as a result of exposure to the elements. The frequency of cleaning will depend on the environment and exposure to various types of elements.

- » Clean railing with standard cleaning vinegar or mild soap and water.
- » For more detailed cleaning recommendations, please refer to the Trex Railing Care and Cleaning guide found on www.trex.com.

PARTS

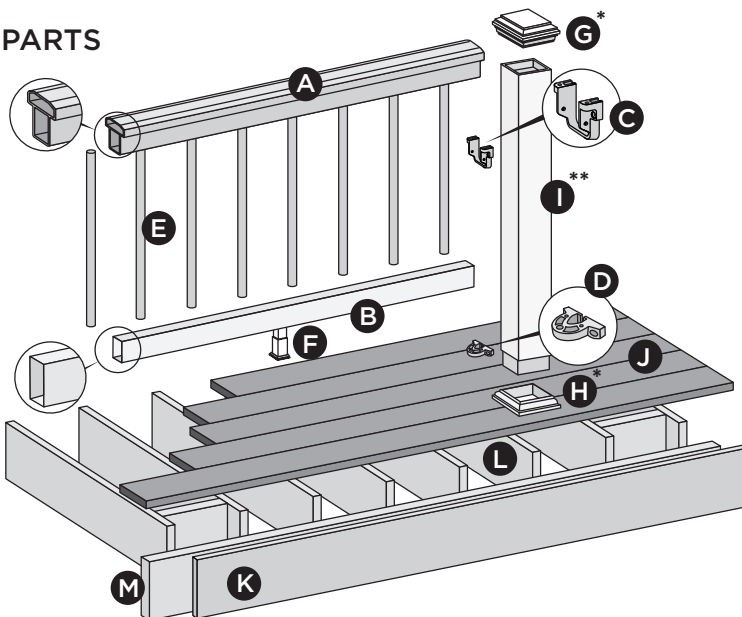

BALUSTER OPTIONS

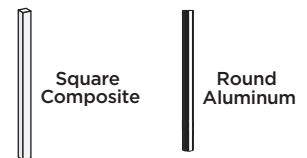

- A. T-Rail
 - B. Bottom Rail
 - C. T-Rail Brackets
 - D. Bottom Rail Brackets
 - E. Aluminum Round Balusters
 - F. Adjustable Foot Block
 - G. Post Sleeve Cap*
 - H. Post Sleeve Skirt*
 - I. Post Sleeve**- 4" x 4" x 48"
 - J. Trex Decking
 - K. Trex Fascia
 - L. Code-approved Wood Joist - 2" x 8"
 - M. Code-approved Wood Rim Joist - 2" x 8" or Larger
- * Item not included in the railing kits.
 ** 4" x 4" post sleeve is designed to fit over 4" x 4" pressure-treated post. Actual size 4.45" x 4.45" x 48"

NOTE: T-Rail Aluminum Rail Stiffener not shown above but is required for all railing installations over 6' (sku SELALTRAILSTIFFNR sold separately).

DETERMINING BALUSTERS NEEDED

Baluster Type	Per 6' Section	Per 8' Section
Horizontal Application	15	20

Screws Supplied with RSB

- C1. Wood screw for attachment of RSB to wood post/composite sleeve
- C2. Self-drilling screw for attachment of RSB to rail

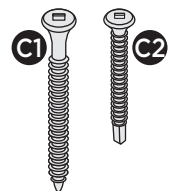

HOW TO INSTALL STANDARD HORIZONTAL RAILING

TREX SELECT T-RAIL®

Read all instructions BEFORE installation.

Installing Pressure-Treated Posts

- PLEASE REFER TO LOCAL BUILDING CODE REQUIREMENTS PRIOR TO ATTACHING PRESSURE TREATED POSTS.

NOTES:

- » Posts are to be installed 6' or 8' clear span to accommodate appropriate railing length.

- » Ensure pressure-treated posts are installed at proper heights so when post sleeves are installed, both the PT post and post sleeve are flush at the top.
- » If using 48" post sleeves, measure carefully to allow for clearance of both rail attachment as well as clearance for post cap attachment, and trim these before installing over pressure treated posts. For 36" rail height, post and post sleeve should be cut at minimum of 40".

TREX SELECT T-RAIL® HORIZONTAL RAILING

Installation Instructions

HOW TO INSTALL STANDARD HORIZONTAL RAILING/CONTINUED

TREX SELECT T-RAIL®

Installing Post Sleeve Skirts and Post Sleeves

2a. If using a 1-piece skirt, slide post sleeve skirt over post and down to rest on decking surface. Slide post sleeve over post and position inside post sleeve skirt.

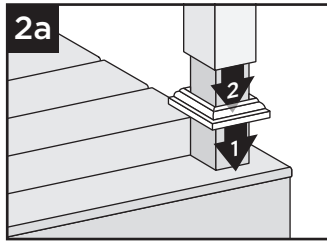

2b. If using a two-piece skirt, slide post sleeve over post and down to rest on decking surface. Snap two piece skirt over post sleeve.

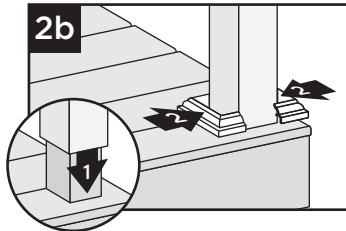

Cutting Railings (if required)

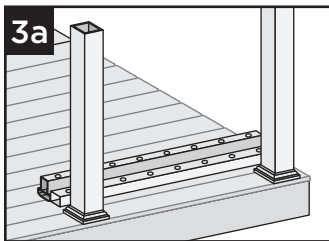

3a. Position bottom rail and T-Rail between posts, ensuring baluster holes are lined up and spaced evenly.

3b. Also allow for a minimum of 1-9/16" (40 mm) on each end of rail for bracket placement AND baluster clearance. Mark rails at intersection of rail and post.

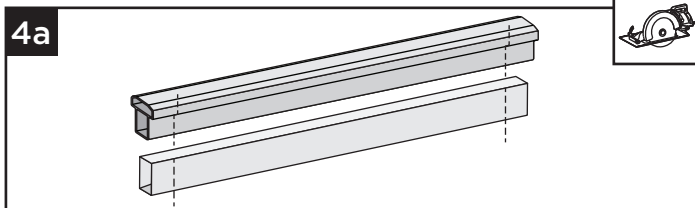
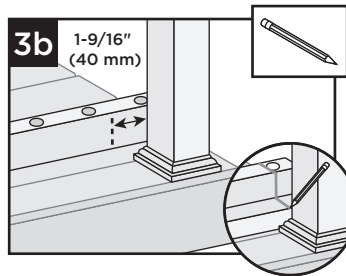

4a. Cut T-Rail and bottom rail to specified length.

Cutting T-Rail Aluminum Stiffener (if required)

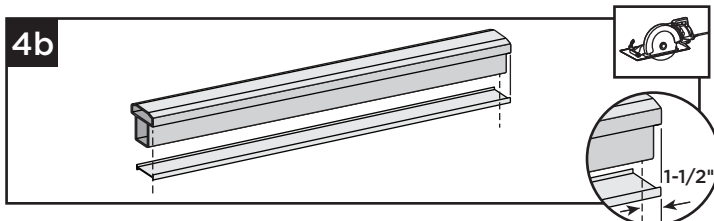

4b. For railing installations over 6' in length, the T-Rail aluminum rail stiffener must be used. For full 8' spans the stiffener will NOT need to be cut. For odd span lengths the stiffener MUST be cut 1 1/2" shorter than the T-Rail.

Attaching Foot Block to Bottom Rail and Adding Weep Holes

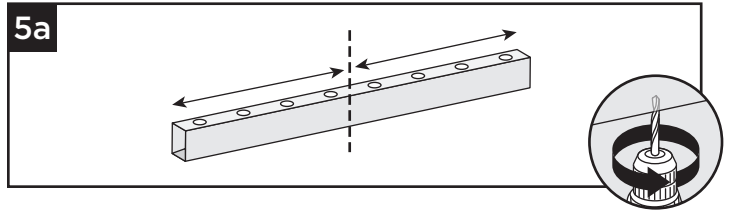

5a. Invert the bottom rail. Center and drill a hole using a 3/16" drill bit. This will be the location for foot block attachment (to be installed last).

5b. Keeping bottom rail inverted, Use same drill bit, center and drill weep holes through bottom rail at 4 evenly spanned locations to allow for water drainage.

IMPORTANT NOTES REGARDING FOOT BLOCK INSTALLATION:

- » Refer to detailed instructions included with foot block prior to installation of railing section as these include other required steps for proper installation.

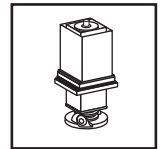

Attaching Brackets to T-Rail

NOTES:

- » **EXTENSION BIT IS HIGHLY RECOMMENDED FOR SCREW ATTACHMENT.**
- » **IF USING T-RAIL ALUMINUM STIFFENER REFER TO STEPS 6b-6d.**
- » For ease of bracket attachment place rail against stationary flat vertical surface along with bracket.

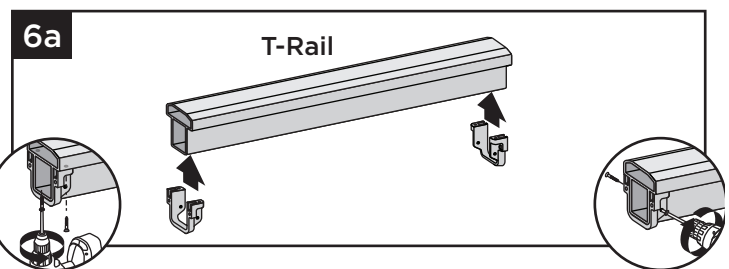

6a. Position brackets on each end of T-Rail on the same side as baluster holes (brackets are always located on the underside of the bottom rail and T-Rail). Attach brackets using four #8-18x1" self-drilling screws (provided). Install upper screws first into underside of T-Rail and then install screws on the side.

HOW TO INSTALL STANDARD HORIZONTAL RAILING/CONTINUED

TREX SELECT T-RAIL®

If Installing T-Rail Aluminum Stiffener

6b. Position one bracket on end of T-Rail and install bracket as stated in step 6a.

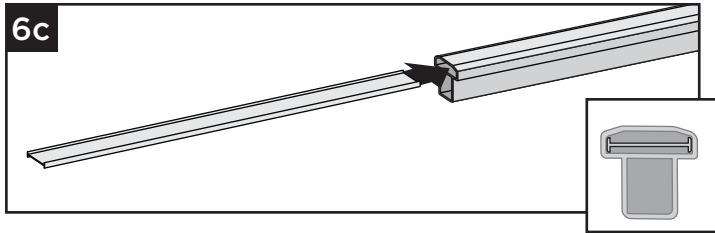

6c. Slide T-Rail aluminum stiffener inside T-Rail as shown.

Note that the stiffener must be slightly shorter to allow for brackets to be installed. Screws from brackets are NOT to penetrate the stiffener.

6d. Install remaining bracket on opposite end of T-Rail as stated in step 6a.

Attaching Brackets to Bottom Rail

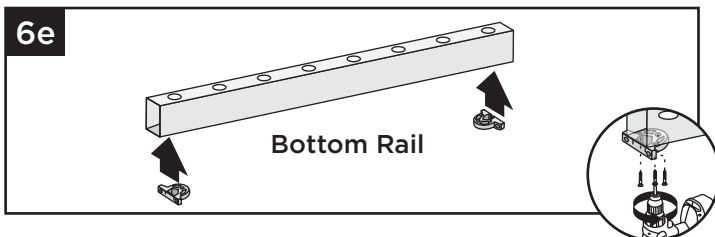

6e. Position brackets on each end of **BOTTOM RAIL** on the **OPPOSITE SIDE** of the baluster holes. Attach brackets using three #8-18x1" self-drilling screws (provided).

Assembling Railing Section

7a. On a clean flat surface lay bottom railing on its side. Make sure to allow enough room for installation of balusters and T-Rail. Place a scrap piece of 1" decking board running parallel to bottom rail for support when installing balusters.

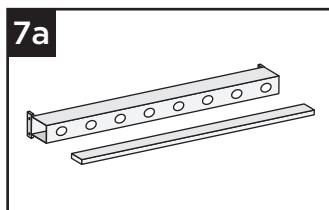

7b. Insert balusters into bottom rail slots until balusters are fully seated.

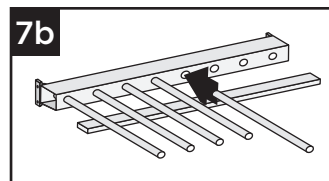

7c. Attach T-Rail to balusters, feeding each baluster into required slots. Start on one end and work towards the other.

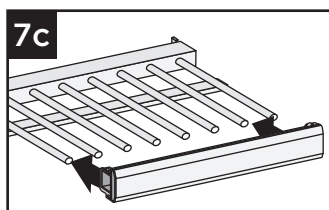

7d. To help temporarily secure the railing section together, place a ratchet strap around the T-Rail and bottom rail and tighten until snug. **DO NOT OVERTIGHTEN AS YOU CAN BEND THE RAILING.**

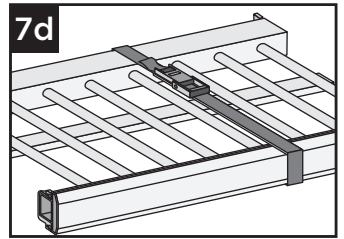

Installing Railing Section to Posts

8a. Using scrap material (i.e. 2 x 4s, decking boards, etc.) cut at least three support blocks at 3-3/4" in height. Place one each on decking surface beside each post and one near center of span.

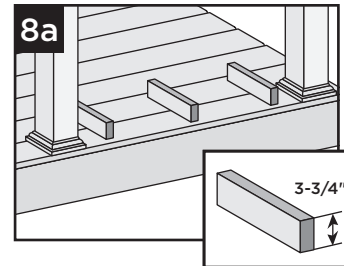

8b. Lift secured railing section up, and **CENTER** this section in between the spanned posts on pre-positioned support blocks.

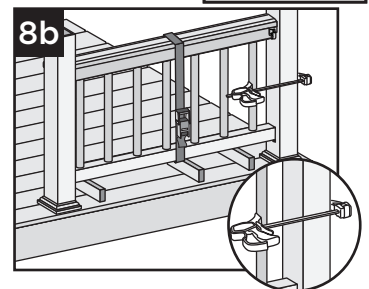

NOTE: To help stabilize railing section use a quick-grip clamp (or other type of clamp) and clamp the first baluster to post sleeve. (**DO NOT OVERTIGHTEN CLAMP.**)

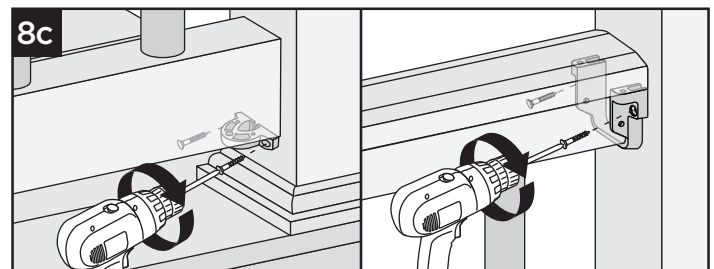

8c. Install both bottom and T-Rail brackets on each side to post using two #9-16 x 2" wood screws (provided). If using a 6x6 post sleeve use #9-16 x 2 1/2" screws (not provided).

NOTE: Screw goes in at slight angle.

Attaching Post Caps and Installing Foot Block

9. Secure post caps with silicone or PVC adhesive (apply adhesive on the inside self-centering/corner tabs). Attach foot block per foot block instructions.

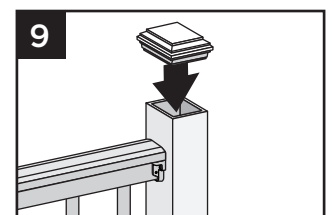

NOTE: Clean up any excess adhesive before it dries.

TREX SELECT T-RAIL® HORIZONTAL RAILING

Installation Instructions

HOW TO INSTALL 22.5° HORIZONTAL ANGLE RAILING

TREX SELECT T-RAIL®

NOTES:

- » Trex Select T-Rail brackets are designed to be installed at 22.5° angle only and only for horizontal applications. Ensure post placements are set to accommodate this angle so railing is install on flat side of post.
- » Brackets must be installed on rails first (see standard horizontal instructions for reference).
- » When installing railing to posts, the brackets may need to be located slightly off center (rails will be centered). Measure and mark first before attachment to rail to ensure railing are centered.

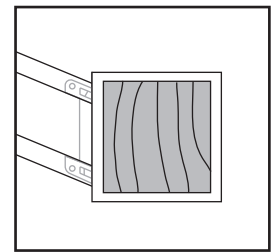
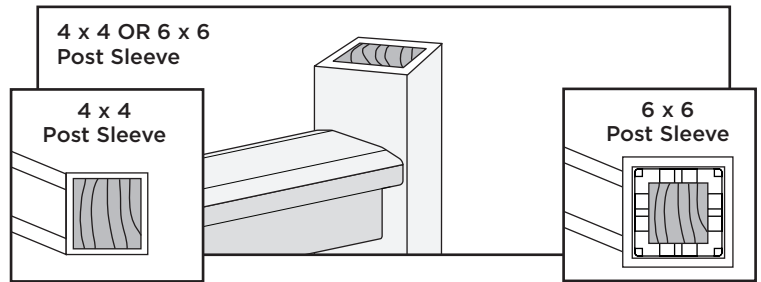

PARTS



Left T-Rail
Angle Bracket

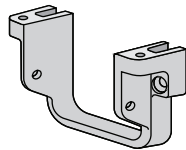

Right T-Rail
Angle Bracket

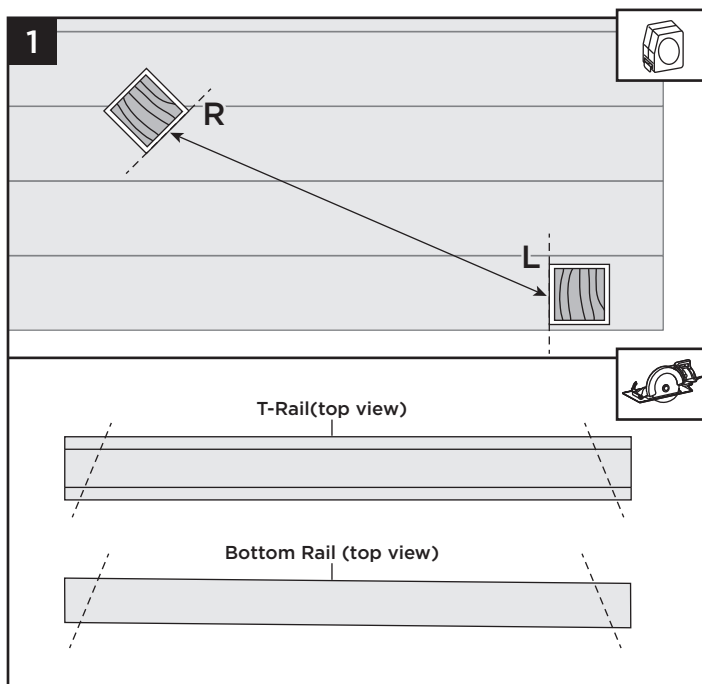

Measure and Cutting Railings

1. Measure between the posts and cut both bottom rail and T-Rail to proper angles.
2. **Attaching Foot Block to Bottom Rail and Adding Weep Holes**
See instructions on page 2.
3. **Attaching Brackets to Railings**
See instructions on page 2.
4. **Assembling Railing Section**
See instructions on page 2.
5. **Installing Railing Section to Posts**
See instructions on page 3.
6. **Attaching Post Caps and Installing Foot Block**
See instructions on page 3.

HOW TO INSTALL SELECT T-RAIL BIRDSMOUTH HORIZONTAL RAILING

TREX SELECT T-RAIL®

NOTES:

- » Use with 4x4 post sleeve only
- » Rails are not to be cut at angles, brackets accommodate railing that are cut flat when required.
- » Brackets must be installed on rails first.
- » For ease of bracket attachment place rail against stationary flat vertical surface along with bracket.

PARTS

**Birdsmouth
T-Rail Bracket**

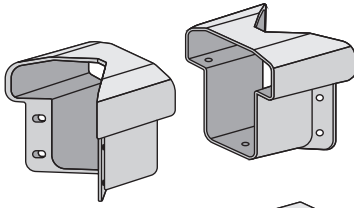

**Birdsmouth
Bottom Rail
Bracket**

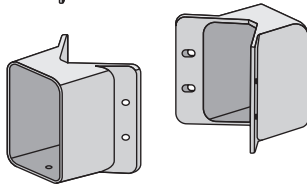

Measuring and Cutting Rails (when required)

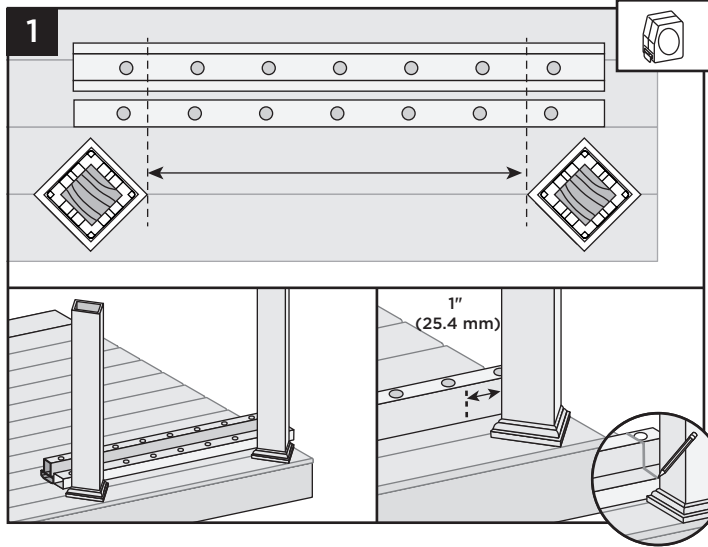

1. Measure from corner-to-corner between posts ensuring baluster holes are at equal distance at each post location. Allow for a clearance of 1" for bracket placement.

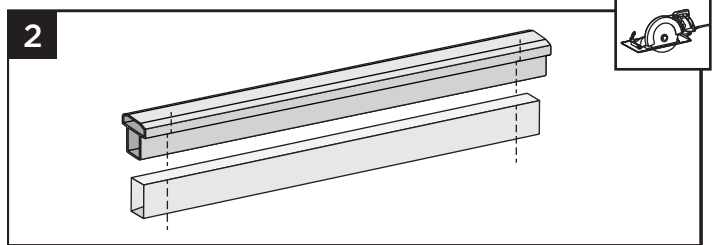

2. Mark rails and cut. Note rails do not need to be cut at an angle. If installing at full span railings may only require slight trim on each side for fit.

3. Attaching Foot Block to Bottom Rail and Adding Weep Holes

See instructions on page 2.

Installing Brackets to Rail

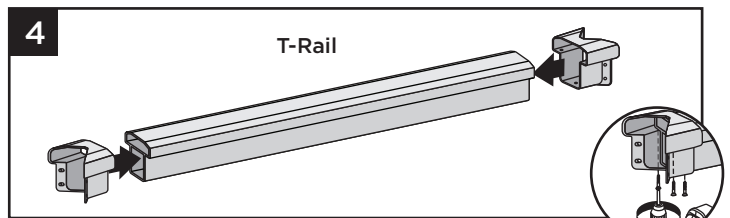

4. Slide T-Rail Birdsmouth bracket onto T-Rail, ensuring that end of rail aligned is with center of bracket, and attach using three #8-18 x 1" self-drilling screws (provided).

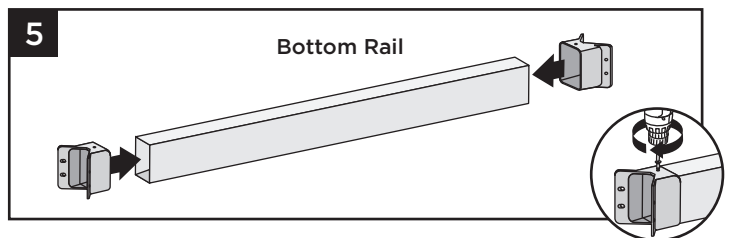

5. Invert the bottom rail (baluster holes facing down) and slide bottom Birdsmouth bracket onto bottom rail, ensuring that end of rail is aligned with center of bracket and bracket is positioned so the screw hole is facing up. Attach using one #8-18 x 1" self-drilling screw (provided).

6. Assembling Railing Section

See instructions on page 2.

TREX SELECT T-RAIL® HORIZONTAL RAILING

Installation Instructions

HOW TO INSTALL SELECT T-RAIL BIRDSMOUTH HORIZONTAL RAILING/ CONTINUED TREX SELECT T-RAIL®

Installing Railing Section to Posts

7a. Using scrap material (i.e. 2 x 4s, decking boards, etc.) cut at least three support blocks at 3-3/4" in height. Place one each on decking surface beside each post and one near center of span.

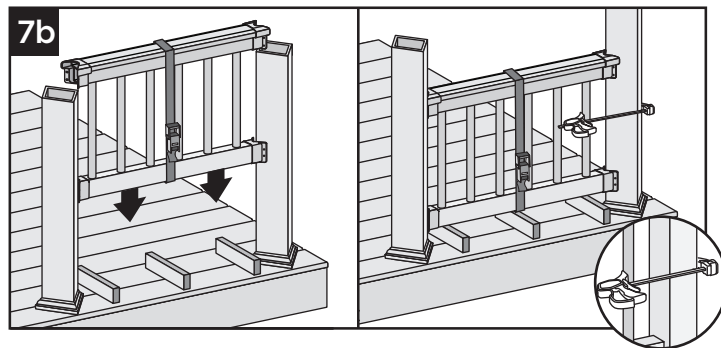
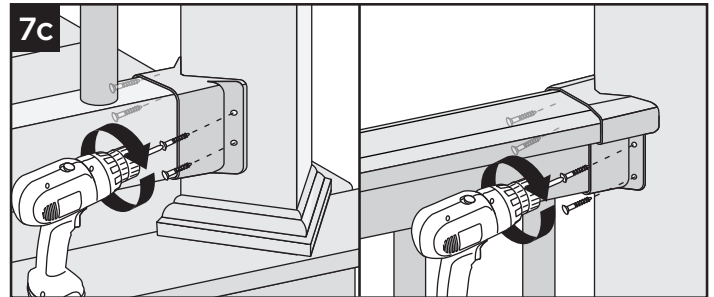
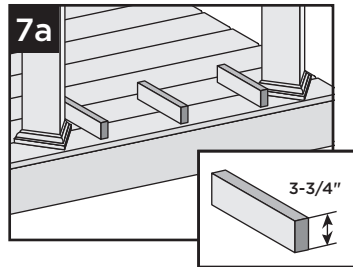

7c. Install both bottom and T-Rail Birdsmouth bracket post sleeve using four #9-16 x 1 3/4" screws (provided) per bracket. Note screws are installed on angle.

8. **Attaching Post Caps and Installing Foot Block**
See instructions on page 3.

7b. Lift secured railing section up above posts and slide down into position between posts.

NOTE: To help stabilize railing section use a quick-grip clamp (or other type of clamp) and clamp the first baluster to post sleeve. (DO NOT OVERTIGHTEN CLAMP.)

